

Minikatalog



Överspänningsskydd



Jordtag



Potentialutjämning



Åskskydd

DEHN protects.



DEHN Sverige AB
Årstaängsvägen 21 c
117 43 Stockholm
www.dehnab.se



Försäljningschef / VD
Johan Bäckman
johan.backman@dehnab.se
+46 708 52 57 56



Key account manager
Alexander Svärd
alexander.svard@dehnab.se
+46 708 52 57 55



Regionansvarig
Eva Forell
eva.forell@dehnab.se
+46 708 52 57 58



Regionansvarig
Anders Ludvigsson
anders.ludvigsson@dehnab.se
+46 708 52 57 59



Om oss

DEHN är ett ledande internationellt verksamt familjeföretag inom elektroteknik baserat i Neumarkt, Tyskland.

Med en omfattande portfölj adresserar DEHN vår tids megatrender. Allt från elektrisk mobilitet och förnybar energi till skydd av kritisk infrastruktur.

Företaget erbjuder lösningar och tjänster på områdena åskskydd, överspänningskydd, potentialutjämning - och mer än 1 100 patent gör DEHN till innovationsledare inom dessa områden.

Företagets produkter skyddar människor och byggnader, anläggnings- och telekommunikationsteknik, processindustrin samt solcellsanläggningar och vindkraftsanläggningar.

Med mer än 2.300 medarbetare över hela världen och mer än 110 års erfarenhet.

Överspänningskydd • Åskskydd • Potentialutjämning



DEHN's gnistgapsteknik, RAC - Rapid Arc Control.



Fas 1: Tändning



Fas 2: Generering av motspänning



Fas 3: Släckningsprocess



Överspänningskydd (230/400 volt)

Överspänningskydd TYP 1+2+3 / Grov-Mellan-Finskydd

Finskyddsnivå upp till 10 meter ledningslängd

1		5279006 956205 5279016 956020	DEHNventil M2 2-poligt Reservpatron
1		5279007 956305 5279017 956030	DEHNventil M2 TNC 255 FM Reservpatron
		5279008 956405 5279018 956040	DEHNventil M2 TNS 255 FM Reservpatron

Överspänningskydd TYP 1+2 / Grov-Mellanskydd

Finskyddsnivå upp till 10 meter ledningslängd

1		5279010 941200 5279011 941205	DEHNshield 2-poligt DEHNshield 2-poligt FM
1		5279012 941300 5279013 941305	DEHNshield TNC 255 DEHNshield TNC 255 FM
1		5279014 941400 5279015 941405	DEHNshield TNS 255 DEHNshield TNS 255 FM

Överspänningsskydd TYP 2 + 3 Mellan-Finskydd (finskyddsnivå upp till 10 meter ledningslängd)

2		5279020 952110 DEHNgard M 275 1+1 5279021 952115 DEHNgard M 275 1+1 FM
2		5279022 952300 DEHNgard M TNC 275 5279023 952305 DEHNgard M TNC 275 FM
2		5279024 952310 DEHNgard M TNS 275 3+1 5279025 952315 DEHNgard M TNS 275 3+1 FM

Med snabbanslutning

2		5279026 942310 DEHNgard MP TNS 275 3+1 5279027 942315 DEHNgard MP TNS 275 3+1 FM
---	---	---

Reservpatroner till DEHNgard M och MP

	5279028 952010 Reservpatron Faspatronen
	5279029 952050 Reservpatron Nollpatron / NPE

För V-ledningsdragning optimal EMC 25

	5279035 952589 V-ledningsklämma 2 x 25mm ² 2 x 16mm ²
---	--

Kompakt Överspänningsskydd TYP 2+3 / Mellan-Finskydd Finskyddsnivå upp till 10 meter ledningslängd

2		5279030 900450 DEHNgard Kompakt 1+1
2		5279031 900455 DEHNgard Kompakt 3+1
2		5279032 900439 DEHNcord 3P TT 275 FM
2		5279033 999937 DEHNcord 2P
2		5279034 900448 DEHNcord 2P IP 65

Överspänningsskydd TYP3 Finskydd

3		5279040 953200 DEHnrail 1fas+nolla 5279041 953205 DEHnrail 1fas+nolla FM 5279042 953010 Reservpatron
3		5279043 953405 DEHnrail FM endast 5279044 953020 Reservpatron
3		5279045 924396 DEHNflex *AS
3		5279046 909230 DEHNprotector 230v
3		5279047 909251 SFL Protector PRO 19" med 6 uttag

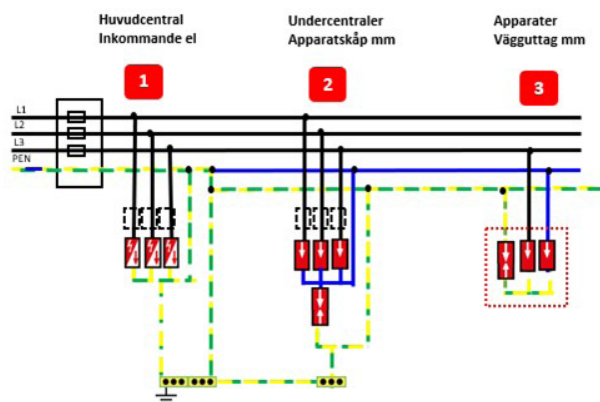
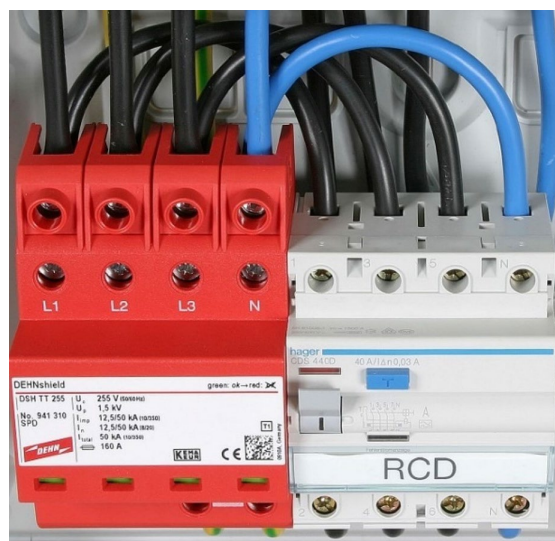

FM = Växlande larmkontakt
*AS = Akustisk signal



Överspänningskydd - Nätverk och signal

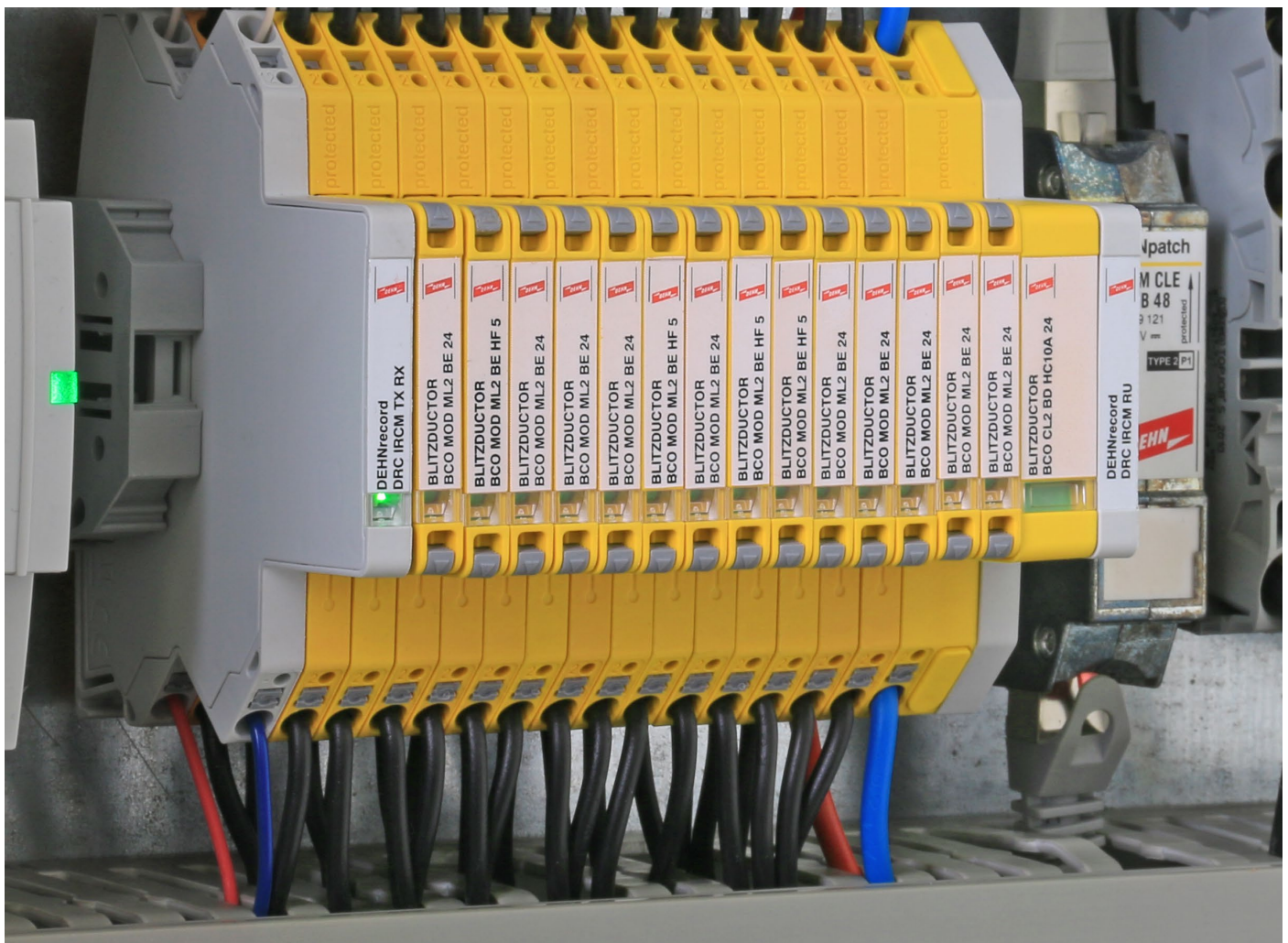







Signalskydd med optisk indikering - utbytbara patroner

			Uc AC	Uc DC	Nominell ström (IL)
	5279070 927222	Signalskydd 12 V	10,6 V	15 V	0,75 A
	5279071 927224	Signalskydd 24 V	23,3 V	33 V	0,75 A
	5279072 927225	Signalskydd 48 V	38,1 V	54 V	0,75 A
	5279073 927210	Signalskydd 180 V	127 V	180 V	1,2A
	Reservpatroner				
	5279074 927022	Reservpatron 12 V 2-poligt			
	5279075 927024	Reservpatron 24 V 2-poligt			
	5279076 927025	Reservpatron 48 V 2-poligt			
	5279077 927010	Reservpatron 180 V 2-poligt			

Signalskydd med optisk indikering - kompakt

			Uc AC	Uc DC	Nominell ström (IL)
	5279078 927922	Signalskydd 12 V kompakt	10,6 V	15V	0,75 A
	5279079 927924	Signalskydd 24 V kompakt	23,3	V 33 V	0,75 A
	5279080 927925	Signalskydd 48 V kompakt	38,1 V	54 V	0,75 A
	5279081 927910	Signalskydd 180 V kompakt	127 V	180 V	1,2A
	5279082 927408	Signalskydd 24 V 10 A kompakt	31,8 V	45 V	10 A

Nätverk - Övervakning - KNX - Koaxial

	5279085 929161	DEHNpatch. Nätverksskydd 10Gbit (Class EA/500 MHz) med optisk indikering
	5279086 929166	DEHNpatch C8 D 4PPOE class S to 100 MHz
	5279088 929309	Adapter för övervakning Påbyggnadsmodul till DEHNpatch som används tillsammans med DEHN Record
	5279090 910710	DEHN Record Övervakningsenhet
	5279091 910499	Nätaggregat 24 V till DEHN Record
	5279087 929221	DEHNpatch Överspänningskydd data IP66 (class E to 250 MHz)
	5279097 925001	DEHN BUSector Överspänningskydd KNX/EIB-Bus 10/350µs
	5279099 909704	DEHNgate - Koaxialskydd Typ 1

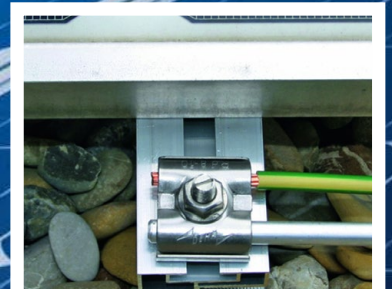

Solcell / E-Mobility



DEHNcord 3P TT 275 FM

- Monteras på DIN-skenor eller med speciella skruvöglor
- Extremt kompakt design
- Dubbel push-in-teknik - För serie- eller parallellkoppling
- Optisk felindikering och växlande larmkontakt

DC-sida

KOMPAKT modell Typ 2 för 1 sträng / 1MPP



5279060 950530 1000 VDC
5279061 950535 1000 VDC FM

Överspänningsskydd Typ 2 för 1 sträng / 1 MPP



5279062 952565 1200 VDC FM
5279063 952048 reservpatron
5279064 952567 1500 VDC FM
5279065 952049 reservpatron

Överspänningsskydd Typ 2 för 2 strängar / 2 MPP



5279066 952514 1000 VDC
5279067 952519 1000 VDC FM
5279068 952051 reservpatron

Överspänningsskydd Typ 2 för 2 strängar / 1 MPP



5279055 900913 1100 VDC
5279063 952048 reservpatron

Överspänningsskydd Typ 2 för 1 strängar / 2 MPP

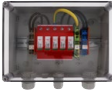

5279056 900921 1100 VDC
5279063 952048 reservpatron

Överspänningsskydd Typ 2 för 2 strängar / 2 MPP



5279057 900923 1100 VDC
5279063 952048 reservpatron

E-Mobility



5279032 900439 DEHNcord 3P TT 275 FM

AC-sida



5279024 952310 DEHNgard M 275 3+1
5279025 952315 DEHNgard M 275 3+1 FM

Kommunikation



5279085 929161 DEHNpatch nätverksskydd
10Gbit (Class EA/500 MHz)
Optisk indikering



5279088 929309 Adapter för övervakning



5279090 910710 DEHN Record
Övervakningsenhet



5279091 910499 Nätaggregat 24 V
till DEHN Record



5279087 929221 DEHNpatch IP66
(class E to 250 MHz)

Funktionsutjämning



0681928 840028 Rundledare ALU 8mmØ / 50mm²
21m/ring



0681934 390051 Multiklämma RD 8 Alu





0681905 540250 Anslutningsklämma UNI
ramverk



0681868 563201 Potentialutjämningskena K12UV
1xFL30x4 + 10x2,5-95mm²/
RD10mm Ø

Fundamentjordelektrod/Potentialutjämning av armering

Varmförzinkat för fundament

	Rundledare 8 mmØ / 50mm ² (cu 6-10mm ²) 0681830 800028 50m/ring
	Rundledare 10 mmØ / 78mm ² (cu 16mm ²) 0681831 800310 30m/ring
	Flatledare 30x3,5 mm / 105mm ² (cu 25 mm ²) 0681832 852335 25m/ring

Klämmor varmförzinkat för fundament

	0681836 390565 Multiklämma 3-5 / 3-10
	0681838 390050 Multiklämma 8-10
	0681839 392050 Multiklämma 8-10 / 16 0681840 308040 Multiklämma 8-16 / 15-25
	0681842 308062 Diagonalklämma 6-28
	0681843 308035 Anslutningsklämma 6-22
	0681812 319201 Kors/skarvklämma RD8-10/FL30
	0681850 372220 Konstruktionsklämma 3-18 mm 0681851 372250 Konstruktionsklämma 18-35 mm

DEHNclip snabbclips för anslutning av armering

	0681844 308130 Snabbclips RD10 / 6-7
	0681845 308131 Snabbclips RD10 / 8-9
	0681846 308132 Snabbclips RD10 / 10
	0681847 308133 Snabbclips RD10 / 12
	0681848 308135 Snabbclips RD8 / 8-9
	0681849 308137 Snabbclips RD8 / 12

NOTERA:
Använd alltid rostfritt syrafast V4A i övergång mellan betong-mark eller betong-luft och som ledare förlagd i mark.

Rostfritt syrafast V4A i mark

	Rundledare 10 mmØ / 78mm ² 0681833 860020 20m/ring 0681834 860050 50m/ring
---	---

Klämmor Rostfritt i mark

	0681837 540271 Multiklämma 3-5 / 3-10 V4A
	0681963 390059 Multiklämma 8-10 V2A
	0681815 319209 Kors/Skarvklämma 8-10 V4A

Gemensamma tillbehör







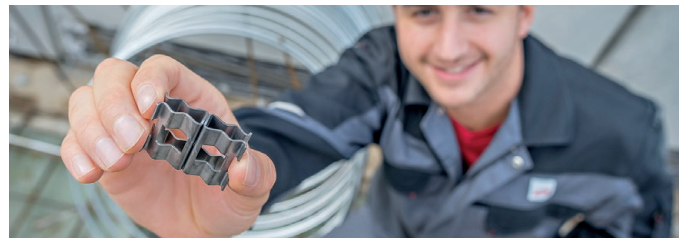

















	0681852 478011 Kontaktplatta M10/M12
	0681854 478098 Skumkudde för kontaktplatta självhäftande
	0681853 478099 Skyddshatt RD10/FL30x3,5
	0681835 308150 Expansionsdel för rörelsefogar

Övergång ALU / Koppar

	0681841 390657 Multiklämma cu/aluminium
---	--













Potentialutjämningskenor

	0681867 563200	Potentialutjämningssskena K12 1xFL30x4 + 10x2,5-95mm ² / RD10mm Ø
	0681868 563201	Potentialutjämningssskena K12UV 1xFL30x4 + 10x2,5-95mm ² / RD10mm Ø
	0681869 563050	Potentialutjämningssskena MS 1xRD8-10/1xFL30x3,5 + 7x2,5-25mm ²
	0681870 563030	Potentialutjämningssskena RK 1x16-95mm ² + 13x2,5-25mm ²
	0681871 563105	Potentialutjämningssskena Mini 6x2,5-25mm ²
	0681872 563014	Skenstöd
	0681873 563016	Skena
	0681874 563011	Klämma 2,5-25mm ²
	0681875 563013	Klämma 16-95 mm ² /RD 8-10mm
	0681876 563015	Kåpa RK
	0681877 472207	Potentialutjämningssskena 6
	0681878 472227	Potentialutjämningssskena 8
	0681879 472217	Potentialutjämningssskena 10
	0681880 472237	Potentialutjämningssskena 12
	0681881 472201	Skrivsats till skena industri (beställs separat)
	0681882 472279	Lock till skena, 6 ansl V2A
	0681883 472269	Lock till skena, 8 ansl V2A
	0681884 472289	Lock till skena, 10 ansl V2A
	0681885 472299	Lock till skena, 12 ansl V2A
	0681886 472309	Jordbock 4 anslutningar V2A
	0681887 472319	Jordbock 6 anslutningar V2A
	0681888 472329	Jordbock 8 anslutningar V2A
	0681889 472339	Jordbock 10 anslutningar V2A
	0681890 472349	Jordbock 12 anslutningar V2A

Gnistgap

	5279098 923023	Isolerande gnistgap
---	-----------------------	---------------------













Anslutningsdetaljer

	0681891 363010	Anslutningsvinkel med bult vzf
	0681892 390479	Anslutningsvinkel V2A
	0681893 301000	Anslutningsbult vzf
	0681894 301009	Anslutningsbult V2A
	0681895 301007	Anslutningsbult cu
	0681898 540920	Anslutningsband 10-27mmØ V2A
	0681899 540912	Anslutningsband 27-168mmØ V2A
	0681920 540900	Klämlås till anslutningsband V2A
	0681921 540901	Anslutningsband 100 m. V2A
	0681841 390657	Multiklämma cu/alu
	0681905 540250	Anslutningsklämma UNI ramverk

Skärmanslutning

	0681908 308421	Ankarskena/skärmanslutning EMC
	0681909 308411	Anslutningsklämma skena/EMC
	0681913 308403	Skärmanslutning 5-10 mm Ø V4A
	0681914 308404	Skärmanslutning 8-14 mm Ø V4A
	0681915 308405	Skärmanslutning 13-18 mm Ø V4A
	0681916 308406	Skärmanslutning 17-21 mm Ø V4A
	0681917 308407	Skärmanslutning 19-26 mm Ø V4A
	0681918 308408	Skärmanslutning 25-33 mm Ø V4A

Åskledarsystem Aluminium

	Rundledare Aluminium 8mmØ / 50 mm² 0681927 840018 148m/ring 0681928 840028 21m/ring
Takledningshållare och anslutningsdetaljer	
	0681929 253015 Takfäste betong RD8
	0681930 202060 Takfäste RD8 vřz
	0681931 374011 Expansionsdel alu
	0681932 365000 Falsklämma RD8 falsbredd 0,7-6mm
	0681933 365059 Falsklämma RD8 V2A falsbredd 0,7-8mm
	0681959 206109 Nockfäste V2A ställbar 180-280mm.
	0681960 206229 Takfäste 475mm V2A
	0681934 390051 Multiklämma ALU
	0681935 385213 Rakskarv RD8 Alu
	0681850 372220 Konstruktionsklämma 3-18 mm 0681851 372250 Konstruktionsklämma 18-35 mm
	0681936 540100 Anslutningsband 2xRD8 16-168mmØ
	0681961 339060 Rännklämma RD8 vřz

Uppfångare 10 mm Ø		
	0681943 101000	Uppfångare 1m
	0681944 102075	Betongsten 8,5 kg
	0681934 390051	Kors/skarvklämma
Uppfångare avsmalnande 16/10 mm Ø		
	0681945 103420	Uppfångare 2m
	0681946 103440	Uppfångare 3m
	0681947 103460	Uppfångare 4m
	0681948 106008	Vinkeladapter 10°
	0681949 102340	Grundsten 17kg
	0681950 102010	Påbyggnadssten 17kg
	0681962 223005	Uppfångarfäste 16 mm
	0681952 106123	Isolerstång för uppfångare
	0681839 392050	Multiklämma RD 8-10/16 vřz
	0681951 274260	Väggfäste för 16mmØ
Övriga tillbehör		
	Anslutningssats för taksäkerhetssystem 0681937 365509 6mmØ 0681938 365519 8mmØ	
	0681958 377015	Överbryggningsfläta 180mm Alu

Uppfångare Teleskopisk 40 mm Ø inklusive trefot



0681953 105711 Teleskopuppfångare 5,2 meter
 0681954 105713 Teleskopuppfångare 6,5 meter
 0681955 105716 Teleskopuppfångare 8,0 meter

Betongstenar 0681949 och 0681950 köps separat

Väggfästen - Stuprörshållare



0681939 206339 Ledningshållare



0681940 207109 Ledningshållare clips



0681941 274160 Ledningshållare skruv



0681942 200029 Stuprörshållare
 50-120mmØ

Övergångsklämma Koppar - Aluminium



0681841 390657 Multiklämma cu/alu

Jordinföring och mätkoppling



0681956 480150 Jordinföringsstång 16mmØ



0681951 274260 Väggfäste RD 16 V2A



0681957 476100 Inspektionsdörr



0681896 302010 Mätkoppling 2 bultar vfz





0681897 301229 Mätkoppling 2 bultar V2A









0681818 556125 Korrosionsskyddstejp







Åskledarsystem Koppar

	Rundledare Koppar 8mmØ / 50 mm ² 0681967 830108 20m/ring		Rundledare DEHNcupal 8mmØ / 50 mm ² 0681968 833008 110m/ring
---	---	---	---

Takledningshållare och anslutningsdetaljer		
	0681973 365007	Falsklämma falsbredd 0,7-6mm
	0681974 365057	Falsklämma falsbredd 0,7-8mm
	0681968 206817	Nockfäste CU ställbar 180-280 mm
	0681970 206227	Takfäste 475mm
	0681971 390057	Multiklämma RD8 cu
	0681972 385207	Rakskarv RD8 cu
	0681975 339067	Ränklämma RD8 cu

Väggfästen - Stuprörshållare		
	0681977 207107	Ledningshållare clips
	0681978 274167	Ledningshållare skruv
	0681979 200027	Stuprörshållare 50-120mmØ

Jordinföring och mätkoppling		
	0681980 480157	480157 Jordinföringsstång cu
	0681951 274260	Väggfäste RD 16 V2A
	0681981 319207	Korsklämma 50-70mm ² cu
	0681818 556125	Korrosionsskyddstejp
Övriga tillbehör		
	0681976 377007	Överbrygningsfläta 180mm

DEHNCUPAL:
Aluminiumbaserad med en kopparbeklädnad gör DEHNCupal till ett mycket prisvärt alternativ till ren koppar.

Låg vikt jämfört med koppar. För användning som takledare och nerledare.



Jordtagssystem

Varmförzinkat



0681831 800310 Rundledare 10mmØ 78mm² varmförzinkad 30m/ring



0681810 620101 Jordspett 20mmØ 1 m vfz



0681811 620015 Anslutningsklämma vfz



0681812 319201 Korsklämma RD8-10 vfz

Rostfritt Syrafast V4A

Enligt Åskskyddshandboken SEK 452 rekommenderas V4A som jordtagsledare



0681833 860020 Rundledare 10mmØ 78mm² rostfri V4A 20m/ring
0681834 860050 Rundledare 10mmØ 78mm² rostfri V4A 50m/ring



0681813 620903 Jordspett 1m 20mmØ V4A



0681814 620915 Anslutningsklämma V4A



0681815 319209 Korsklämma RD 8-10 V4A

Gemensamma tillbehör



0681816 620001 Spets för jordspett



0681817 620002 Slaghuvud



0681818 556125 Korrosionskyddstejp



0681819 573000 DEHNIT Jordförbättringsmedel 25KG



0681820 549000 Mätbrunn utan klämma

Koppar



Rundledare Koppar 8mmØ / 50 mm²
0681967 830108 20m/ring



0681981 319207 Korsklämma 50-70mm² cu



Jordnät

- för bland annat stegspänningssänkande åtgärder

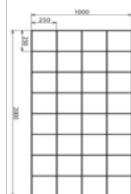

0681821 618214 Jordnät rostfri V4A
Mått: 2000x1000x4 mm











0681837 540271 Multiklämma RD3-5 /3-10 V4A



Rostfritt vs varmförzinkat < 5 år

DEHN HVI light plus

Isolerat åskskyddssystem upprätthåller separationsavståndet

Gemensamma tillbehör	
	0681984 819609 Åskledare HVI light plus Köps på kapade längder *A
	0681929 253015 Takfäste betong RD8
	0681988 253026 Adapter för HVI 20-23mmØ/betongsten
	0681989 202852 Falsklämma för HVI falsbredd 0.7-8 mm
Fristående uppfångare	
	0681986 819682 Uppfångar-set 2,7 meter inklusive 3-bensstativ *B
	0681949 102340 Grundsten 17kg
	0681950 102010 Påbyggnadssten 17kg
Väggmonterade uppfångare	
	0681991 105674 Uppfångare 2,4 meter
	0681992 105342 Väggfäste 40-50mmØ 46mm
	0681993 105348 Väggfäste 40-50mmØ 110 mm
	0681994 105344 Väggfäste 40-50mmØ 150-200 mm
Väggfäste	
	0681995 275259 Ledningshållare för HVI
Kopplas till jordtag	
	0681820 549000 Mätbrunn utan klämma
	0681815 319209 Korsklämma 8-10 V4A

*A HVI köps på Kapade längder mellan 6 - 70 meter

*B Stenar köps separat

DEHN HVI light plus



Isolerat åskskydds-system upprätthåller separationsavståndet



- ✓ Övermålningsbar
- ✓ EX-godkänd
- ✓ Kräver ingen potentialutjämning av mantel
- ✓ Komplet system
- ✓ Separationsavstånd < 600 mm
- ✓ Skyddar mot beröringsspänning *

* SS-EN 62305-3

Fristående uppfångare inklusive stativ

Varmförzinkat		
	0681996 105910	Uppfångare 10 meter
	0681997 105922	Uppfångare 12 meter
	0681998 105924	Uppfångare 14 meter
	0681949 102340	Grundsten 17kg
	0681950 102010	Påbyggnadssten 17kg





- Överspänningsskydd
- Åskskydd
- Potentialutjämnning

DEHN Sverige AB
Årstaängsvägen 21 c
117 43 Stockholm
Sweden

www.dehnab.se

DEHN SE
Hans-Dehn-Str. 1
92318 Neumarkt
Germany

www.dehn-international.com

DEHN protects.

